

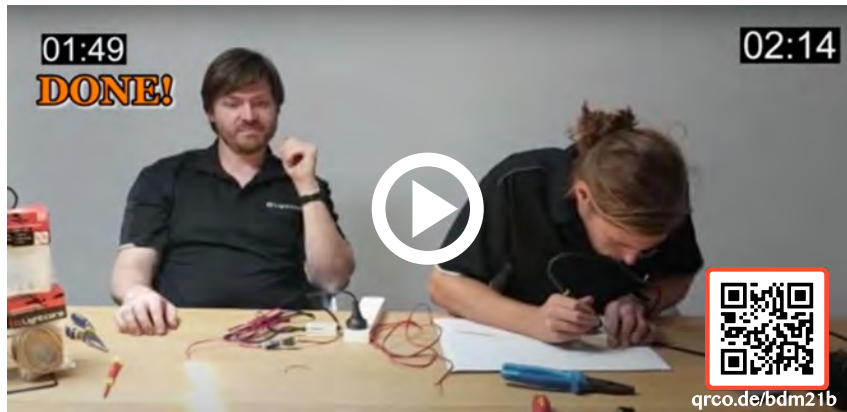

VIDEO RESOURCES

  @LIGHTCORE_LIGHTING



STRIPCLIPZ VS. SOLDERING

Watch our ultimate connection challenge.



STRIPCLIPZ IN ACTION

Watch how StripClipz fixed a Kitchen Lighting warranty issue.

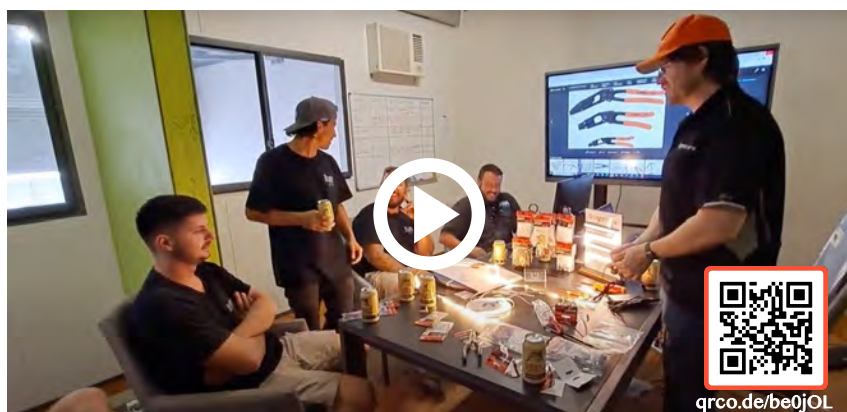

STRIPCLIPZ X LIGHTCORE TRAINING

Our recent training session with KVA Group on the Gold Coast.

AVAILABLE THROUGH YOUR WHOLESALER

Lightcore is proud to hold active accounts with ALL major electrical wholesalers.
If you don't have a preferred wholesaler please get in touch and we'll refer you to one
in your area.



CNW ELECTRICAL

Account #: 10138

<https://shop.cnw.com.au/>



LAWRENCE & HANSON

Account #: 61114082

<https://www.lh.com.au/>



MM ELECTRICAL

Account #: 64054

<https://www.mm.com.au/>



MIDDY'S ELECTRICAL

Vendor ID: 64054

<https://www.middys.com.au/>



SHERRIFF ELECTRICAL

Account #: 2399

<https://shop.sherriff.com.au/>



REXEL ELECTRICAL

Account #: H42320

<https://www.rexel.com.au/are/>



**DOT-FREE LED
& PROFILES**





DOT-FREE 8MM

FEATURES

- Premium DOT-FREE continuous LED strip with most chip/m quantity available giving brightest and most uniform effect.
- Extremely flexible, highly reliable and durable.
- High lumen output
- Easy installation.
- Custom lengths, 5m, 50m reels.
- 5 year warranty.
- Available in IP20 and IP65 Nano.

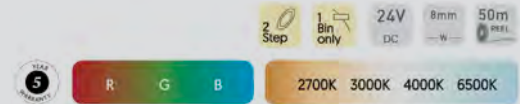

SPECIFICATION

Basic Parameters

Size	IP20/IP65: 8mm x 1.6mm x 50000
Input Voltage	24VDC
Input Current	0.42A/1m and 1.8A/5m
Typical power	10W/1m and 43.2W/5m
Max power	11.2W
Lifetime	L90 >36,000 hours
LED/m	
Continuous max run	10m
Colour / CCT	2700K, 3000K, 4000K, 6500K, R, G, B
Bin/Step (SDCM)	1 bin 2-step MacAdam ellipse
IP Rating	20 / 65
CRI	>90
Energy Efficiency Class	A+
Warranty	5 years
Control	Phase cut (leading & trailing)/0-10V/1-10V/DMX/DALI
Cutting Increment	29.41mm
Connection Tails	
Beam Angle	60°, 90°, 170° Beam

Product Ordering

CODE	COLOUR	LM/M	IP RATING	STOCKED
DFR-24-8-2700-20	2700	820	20 / IP65	YES
DFR-24-8-3000-20	3000	900	20 / IP65	YES
DFR-24-8-4000-20	4000	980	20 / IP65	YES
DFR-24-8-6000-20	6000	1000	20	YES

Technical Diagram

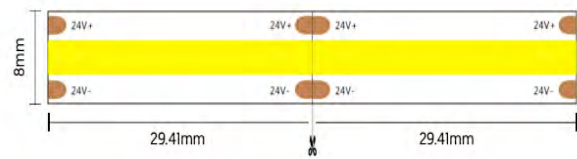

Ingress Protection (IP)



NO IP20/NA IP65
8mmx1.6mmx50000

CODE	COLOUR	LM/M	IP Rating	STOCKED
DFR-24-8-R-20	Red	620-630nm	20	YES
DFR-24-8-G-20	Green	520-530nm	20	YES
DFR-24-8-B-20	Blue	450-460nm	20	YES

*For IP65 Nano, replace -20 with -65NA

DOT-FREE 4MM

FEATURES

- Thinnest dot-free continuous strip light on the market.
- Premium LED strip providing DOT-FREE effect.
- Extremely flexible, highly reliable and durable.
- Custom lengths and 5m reels.
- Plug'n'play connectors for easy on-site customisation.
- For bespoke joinery and fine niche applications.

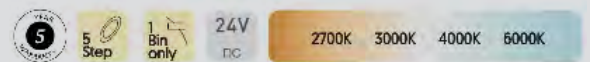

SPECIFICATION

Basic Parameters

Size	IP20/IP65: 4mm x 1.6mm x 3000 or custom
Input Voltage	24VDC
Input Current	0.375A/1m and 0.79A/2.5m
Typical power	9W/1m and 19W/2.5m
Max Power	10W
Lifetime	L90 >36,000 hours
LED/m	120/m
Continuous max run	3m
Colour / CCT	2700K, 3000K, 4000K, 6500K
Bin/Step (SDCM)	1 bin 5 step MacAdam ellipse
CRI	>90
Energy Efficiency Class	A+
Warranty	5 years
Control	0-10V
Cutting Increment	16.67mm
Connection Tails	Custom / 2x2mm for 5m reel
Beam Angle	170° Beam

Product Ordering

CODE	COLOUR	LM/M	IP RATING	STOCKED
DFR-24-4-2700-20	2700K	610	20	YES
DFR-24-4-3000-20	3000K	680	20	YES
DFR-24-4-4000-20	4000K	760	20	YES
DFR-24-4-6000-20	6500K	810	20	S/O

S/O: Special Order
The above is testing data for a 1m LED strip without IP (NO)
Any IP will change the lumen values listed above
≤ smaller than or equal to

Technical Diagram

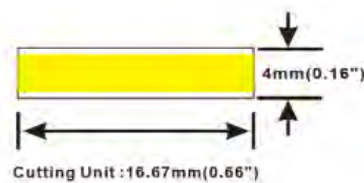

Ingress Protection (IP)

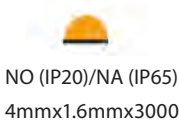

Recommended Solution / Accessories

TRANSFORMERS

GSTRAN-60-24-C
Non-dimmable ≤5m



PDV-75-24
dimmmable ≤5m



PDV-150-24 (IP66)
dimmmable ≤10m



CONNECTORS

DFR-4-S2S
strip to strip connector



DFR-4-S2P
strip to power connector



PROFILES

0709-X-F
2500mm, white/black

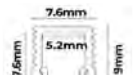

0812-X-F
2500mm, white/black

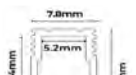

970085-M-P(WHT)

970083-M-P(BLK)

2000mm,
9mm(w)x6mm(h)

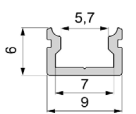

Lightcore PROFILES

4MM DOT-FREE STRIP

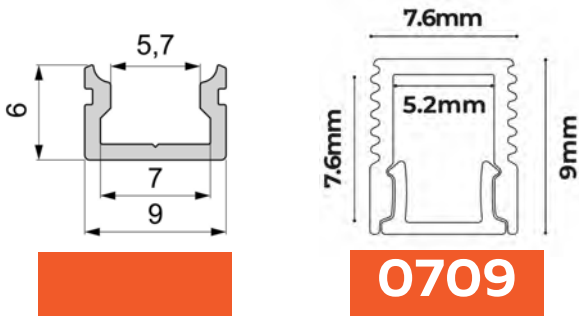

0709



0812

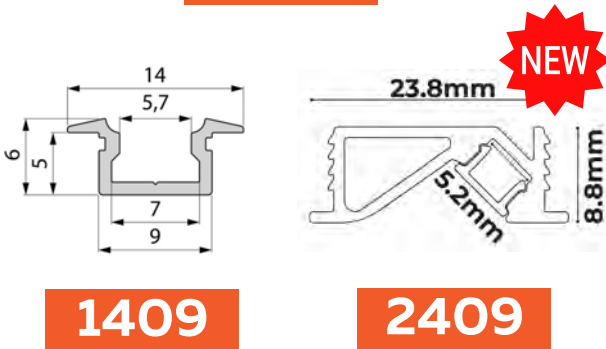

1409

2409

8MM TO 12MM STRIP

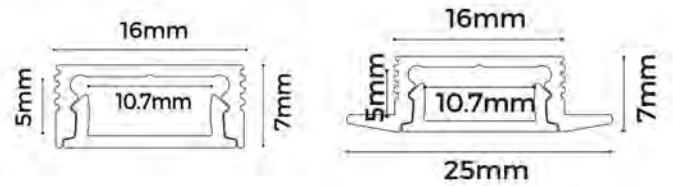

1607

2507

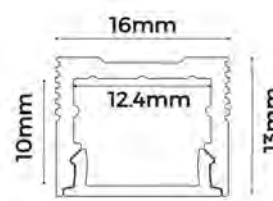

1613

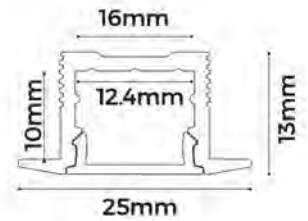

2513

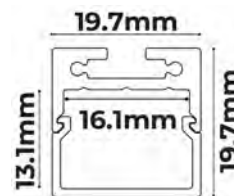

1911

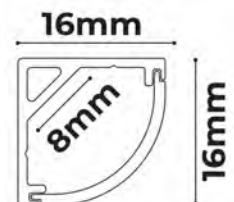

1607

IP65 IN-GROUND & FLOOR

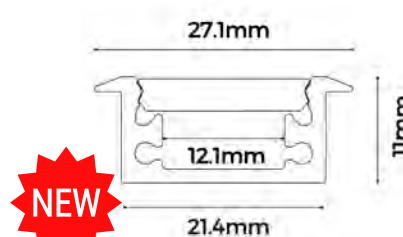

2711

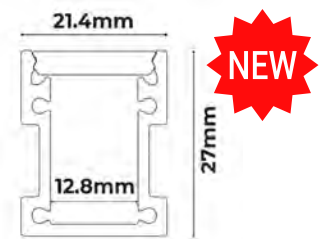

2127

- White/Black are the most popular. Alu also available.
- Comes with White frosted or Black diffuser.
- 2500mm lengths, custom cutting available upon special request.
- Supplied with mounting clips & matching endcaps.
- Kept in stock in Brisbane.
- Check out our Instagram - it is a good resource for other jobs Lightcore does.
- Get in touch with Lightcore directly and reference your wholesaler for the best service and pricing.
- Lightcore will work directly with the contractor to figure the job out, but all orders go through the wholesaler.
- Lightcore also does project solutions, very good with D&C and custom linear solutions.
- Better product, better price, better lead times.
- Active 30 Day EOM account.

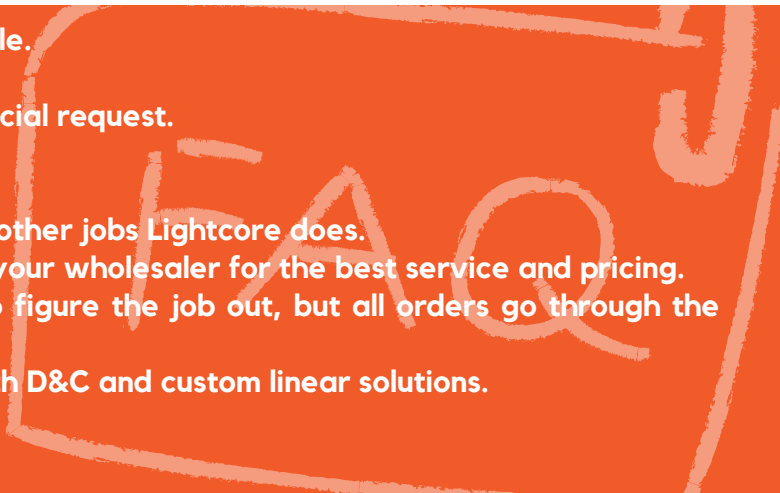

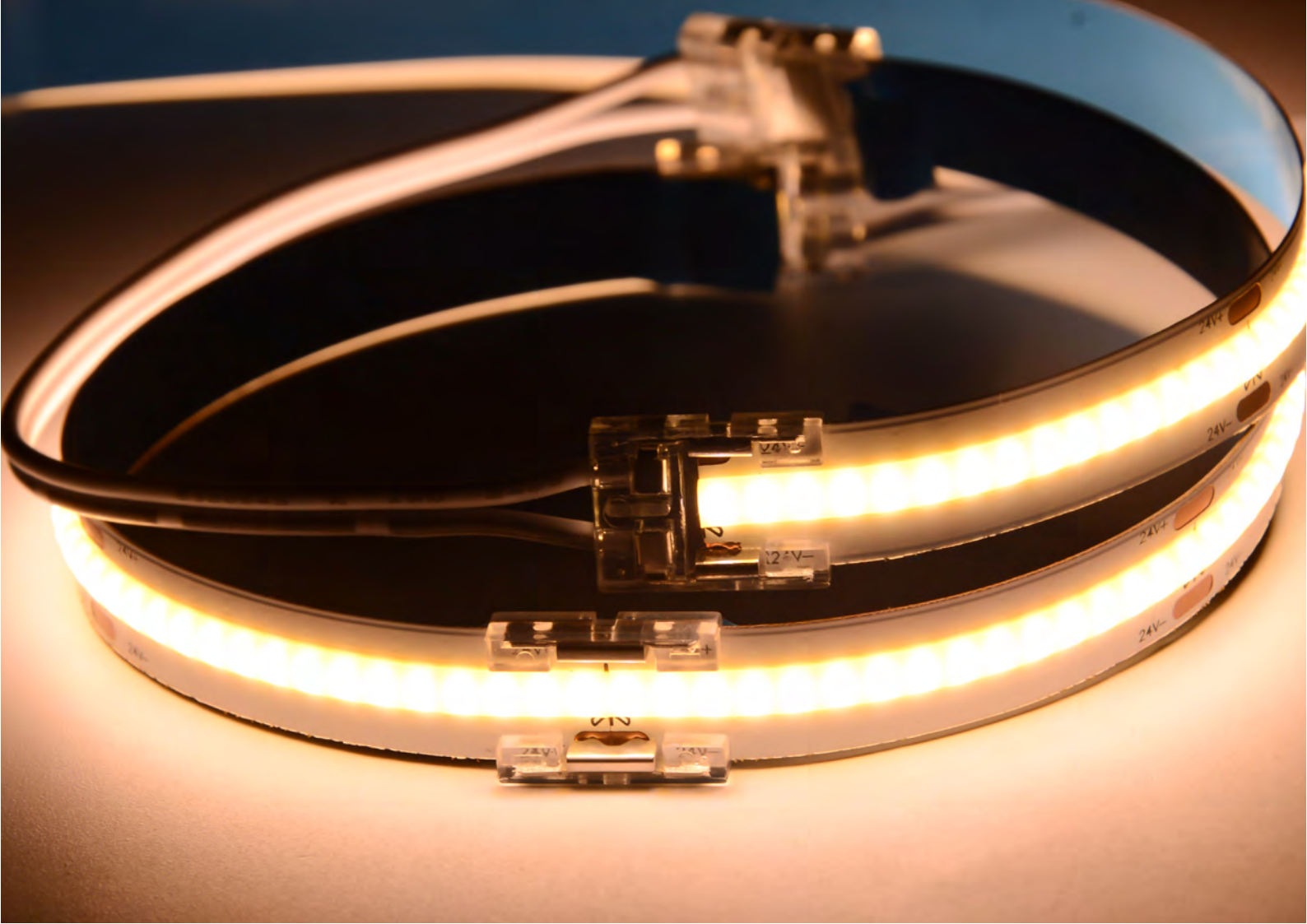

STRIP **CLIPZ**
by LIGHTCORE
connections made easy

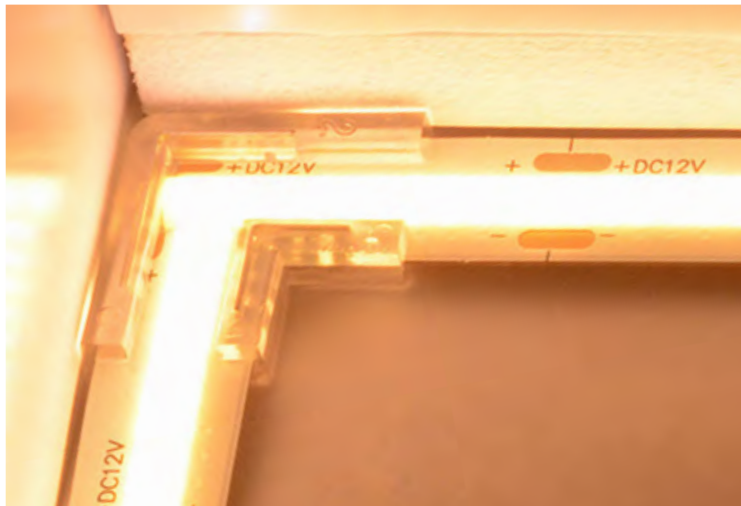

SCAN FOR GUIDE



STRAIGHT CONNECTOR

2-CORE 8MM

FEATURES

- Click'n'Play straight LED strip connector.
- No soldering needed!
- Ultra slim and ultra strong.
- Very fast, easy and reliable.
- Gapless connection, no break in light.
- Fits any profile that fits 8mm strip.
- Works with any 8mm 2-core (single colour) strip light.



SPECIFICATION

Basic Parameters

Size	15.6mm x 9.6mm x 3.3mm
Pin Quantity	2 Pin (single colour)
Connection Type	Strip to Strip
Colour	Transparent
Temperature Resistance	105° C
Voltage	DC 3-24 V
Current	5.5A
IP Rating	IP20
Strip Width	8mm

Technical Diagram



Connection Instructions

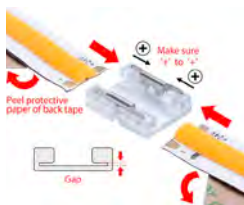

1. Push strip through the gap



2. Make strip meet at middle line

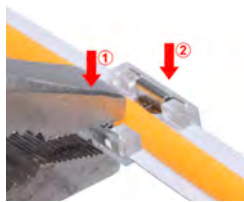

3. Clamp metal teeth to pierce PCB one by one



4. Connection completed

Recommended Solution/Accessories

LED STRIPS
DFR IP20

PROFILE
1607

TRANSFORMER
PDV-75-24 (DIM)

CONNECTORS

SC-FEED-2C

SC-CNR-2C

SC-WIRE-STR-2C



Product Ordering

CODE	SHAPE	TYPE	STOCKED
SC-STR-2C	Straight	Strip to Strip	YES



SCAN FOR GUIDE



FEED CONNECTOR

2-CORE 8MM

FEATURES

- Click'n'Play LED strip feed connector.
- Consistent solder-grade connection.
- Very fast, easy and reliable.
- Supplied with 2000mm tail.
- No break in light.
- Fits any profile suited for 8mm strip.
- Works with any 8mm 2-core (single colour) strip light.



SPECIFICATION

Basic Parameters

Connector Size	15.6mm x 9.6mm x 3.3mm
Feed Length	2000mm
Pin Quantity	2 Pin (single colour)
Connection Type	Strip to Power
Colour	Transparent
Temperature Resistance	105° C
Voltage	DC 3-24 V
Current	5.5A
IP Rating	IP20
Strip Width	8mm

Technical Diagram

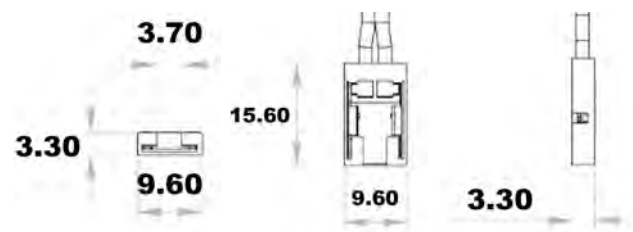

Connection Instructions



1. Push strip through the gap



2. Make strip meet at middle line



3. Clamp metal teeth to pierce PCB one by one



4. Connection completed

Recommended Solution/Accessories

LED STRIPS
DFR IP20

PROFILE
1607

TRANSFORMER
PDV-75-24 (DIM)

CONNECTORS

SC-STR-2C

SC-CNR-2C

SC-WIRE-STR-2C

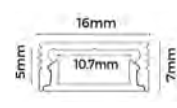
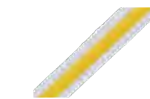

Product Ordering

CODE	SHAPE	TYPE	STOCKED
SC-FEED-2C	Straight	Strip to Power	YES

SCAN FOR GUIDE



CORNER CONNECTOR

2-CORE 8MM

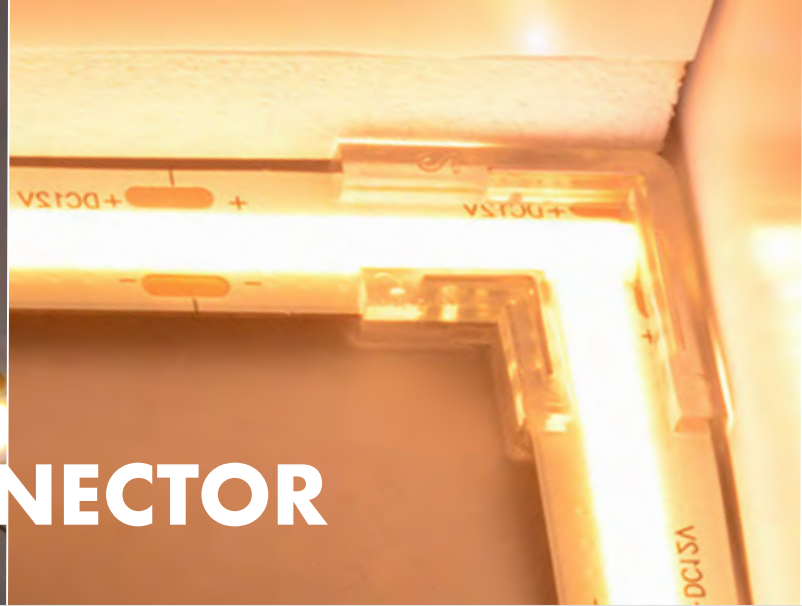

FEATURES

- Click'n'Play LED strip corner connector.
- Consistent solder-grade connection.
- Very fast, easy and reliable.
- Break-free lighting around corners
- Single feed compatible
- Fits any profile suited for 8mm strip.
- Works with any 8mm 2-core (single colour) strip light.



SPECIFICATION

Basic Parameters	
Size	17mm x 17mm x 3.5mm
Pin Quantity	2 Pin (single colour)
Connection Type	Strip to Strip
Colour	Transparent
Temperature Resistance	105° C
Voltage	DC 3-24 V
Current	4A
IP Rating	IP20
Strip Width	8mm

Technical Diagram

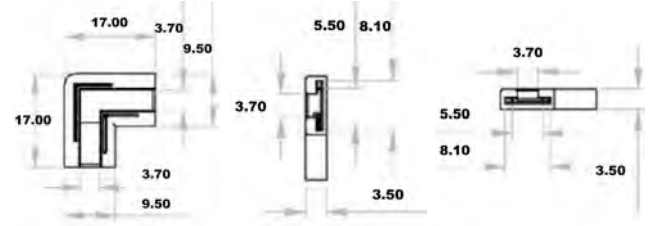

Connection Instructions

1. Insert LED Strip
2. Make sure 2 solder pads touch together
3. Clamp conductor for piercing PCB
4. Connection completed

Recommended Solution/Accessories

LED STRIPS DFR IP20		CONNECTORS SC-STR-2C	
PROFILE 1607		SC-FEED-2C	
TRANSFORMER PDV-75-24 (DIM)		SC-WIRE-STR-2C	

Product Ordering

CODE	SHAPE	TYPE	STOCKED
SC-CNR-2C	Corner (L)	Strip to Strip	YES





IN-LINE WIRE CONNECTOR

FEATURES

- Click'n'Play unpluggable wire connector
- Makes extending cable for single, RGB, RGBW cable easy.
- Consistent solder-grade connection.
- Very fast, easy and reliable.
- No cable stripping required
- Flame Retardant Rating: UL94v-1



SPECIFICATION

Basic Parameters

Size	26mm x 15mm x 7mm
Pole Quantity	2 Pole
Connection Type	Wire to Wire
Colour	Transparent
Temperature Resistance	105° C
Voltage	36 VDC
Current	9A
IP Rating	IP40
Workable Wire	22-20 AWG 0.34~0.54 mm ²

Connection Instructions

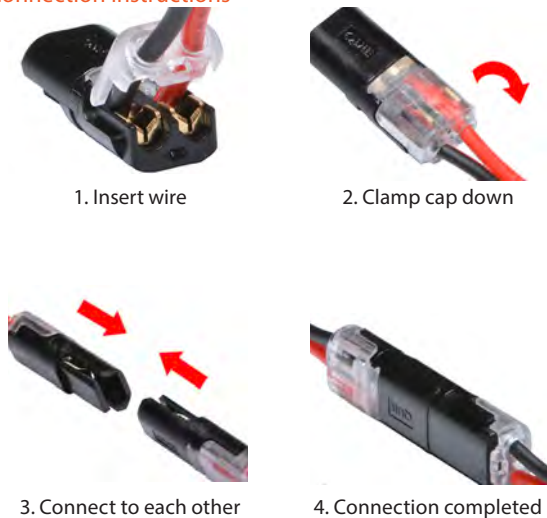

Technical Diagram

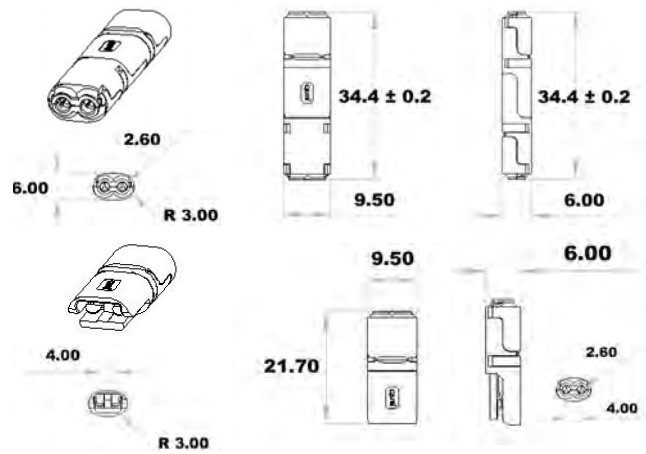

Recommended Solution/Accessories



Product Ordering

CODE	SHAPE	TYPE	STOCKED
SC-WIRE-STR-2P	Straight	Wire to Wire	YES



SWEEP SENSOR

FEATURES

- Touch-free hand sweep sensor.
- No soldering needed!
- Flexible & cuttable.
- Very fast, easy and reliable.
- Fits any profile that fits 8mm strip.
- Can run up to 8m of dotfree (DFR) strips.
- On/Off Switch: Hand Sweep
- Dimming: Hand Holding for 1 Second

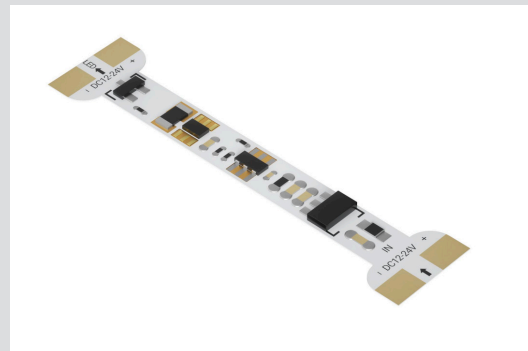

SPECIFICATION

Basic Parameters

Size	40mm x 10mm
Trimmed Width	5-10mm
Sensitive Distance	80mm
Dimming Type	Cycle Dimming
Dimming Trigger	Hold for 1 sec
Voltage	DC 5-24 V
Current	3.5A
Max Load	80W
LED Color	Mono
Strip Width	5-10mm

Connection Instructions

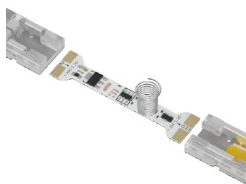

1. Prepare sensor & stripclipz

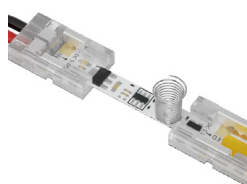

2. Insert sensor in stripclipz

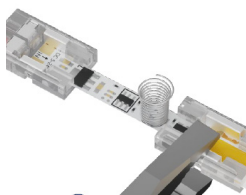

3. Clamp stripclipz



4. Install sensor & stripclipz in the profile.

Technical Diagram

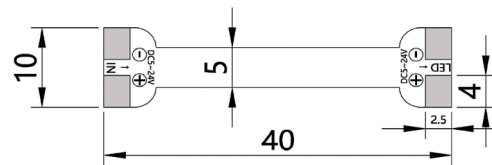

Recommended Solution/Accessories

LED STRIP
DFR IP20



PROFILE
1607

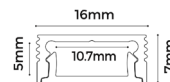

TRANSFORMER
PDV-75-24 (DIM)



CONNECTORS

SC-FEED-2C



SC-CNR-2C



SC-WIRE-STR-2C



Product Ordering

CODE	SHAPE	TYPE	STOCKED
SC-SWEEP-2C	N/A	Strip to Strip	YES

TRANSFORMER MATCH LIST

NON-DIMMABLE



UP TO 2 METRES
GSTRAN-25-24-C
24V DC, 25 WATTS
93 x 54 x 36mm



UP TO 4.5 METRES
GSTRAN-60-24-C
24V DC, 60 WATTS
125 x 50 x 31.5mm



UP TO 7.5 METRES
GSTRAN-90-24-C
24V DC, 60 WATTS
145 x 60 x 32mm



UP TO 12 METRES
HLG-150-24
12V DC, 150 WATTS
228 x 68 x 38.8mm
IP67 External Rated



UP TO 20 METRES
HLG-240-24
24V DC, 240 WATTS
244.2 x 68 x 38.8mm
IP67 External Rated



UP TO 27 METRES
HLG-320-24
24V DC, 60 WATTS
252 x 90 x 43.8mm
IP67 External Rated

All GST & HLG transformers come with flex & plug to suit.

DIMMABLE



UP TO 2.5 METRES
PDV-30-24
24V DC, 30 WATTS
155 X 54 X 20mm



UP TO 6 METRES
PDV-75-24
24V DC, 75 WATTS
180 x 60 x 35mm



UP TO 8 METRES
PDV-100-24
24V DC, 100 WATTS
230 x 70 x 43mm
IP67 External Rated



UP TO 12 METRES
PDV-150-24
24V DC, 150 WATTS
265 x 78 x 47mm
IP67 External Rated



UP TO 16 METRES
PDV-200-24
24V DC, 200 WATTS
265 x 78 x 47mm
IP67: External Rated



UP TO 25 METRES
PDV-300-24
24V DC, 300 WATTS
276 x 78 x 47mm
IP67: External Rated



UP TO 30 METRES
PDV-360-24
24V DC, 360 WATTS
276 x 78 x 47mm
IP67: External Rated

All PDV transformers come with 1m flex and plug. Before purchasing this product make sure it will be compatible with the dimming switch you're using. You can download switch compatibility sheet by click [HERE](#)

